

Updated: 4/24/17

2017 F250 Bi-fuel Schematic CNG Prep.

Alternative Fuel Control Module (AFCM)

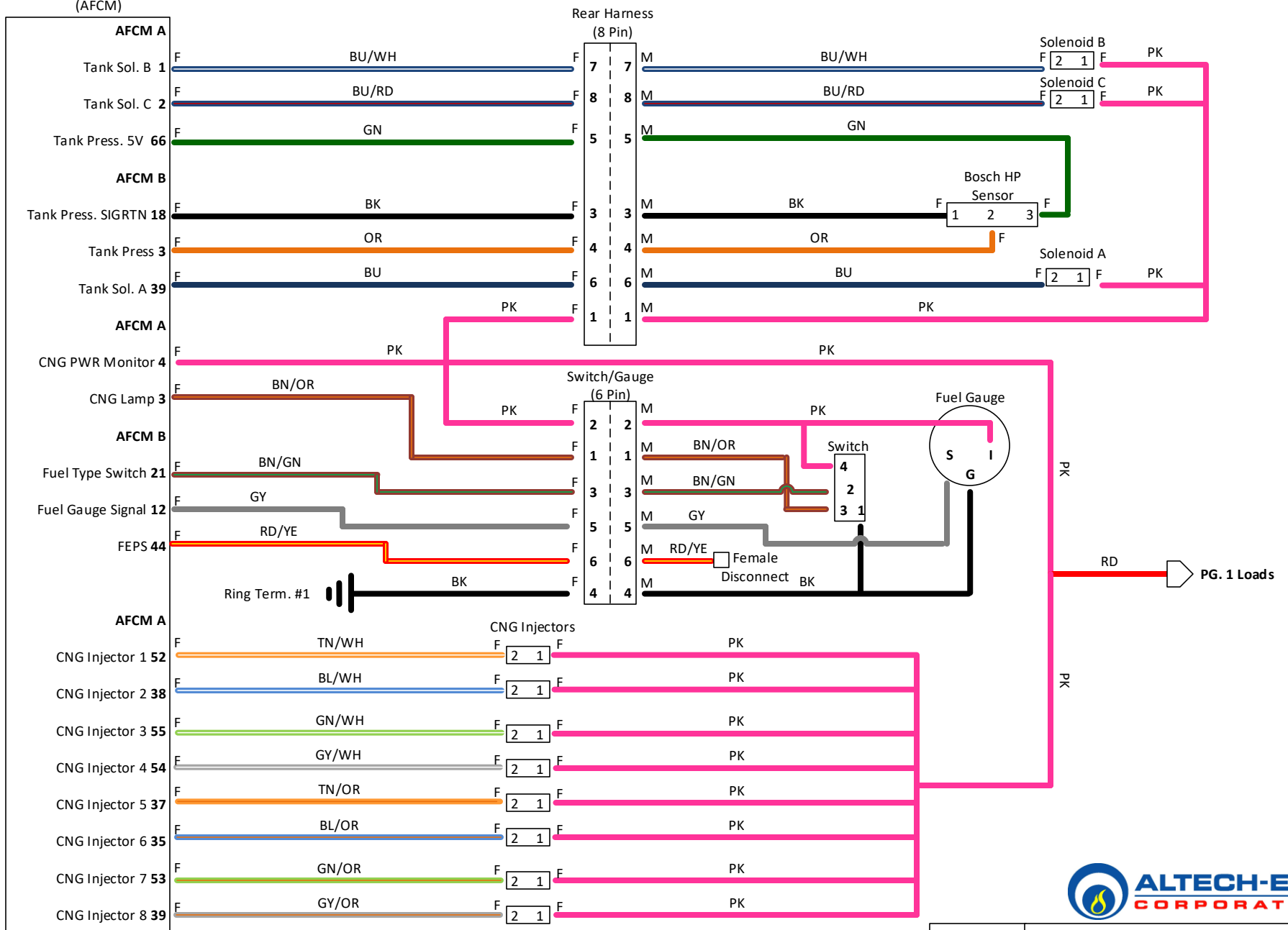

Updated: 4/24/17
 2017 F250 Bi-fuel Schematic
 CNG Prep.

Connector Face

AFCM A

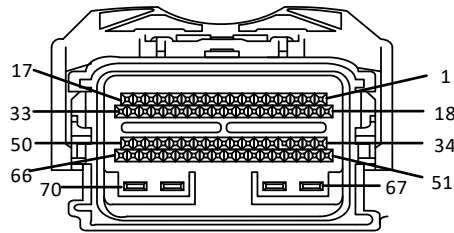

AFCM B

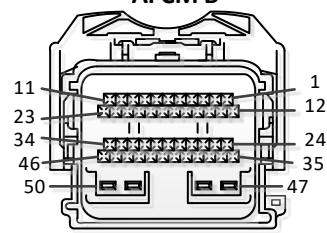

PCM C175E

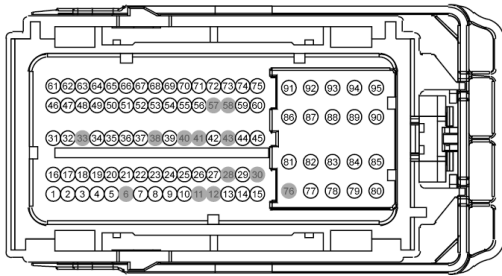

PCM C175B

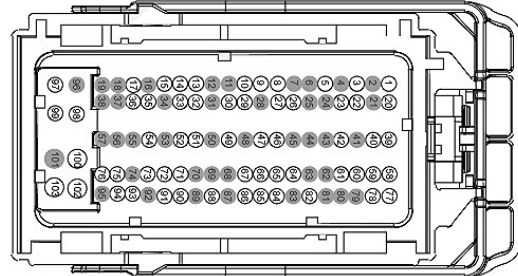

Ford CNG Prep Connector

Male (M)

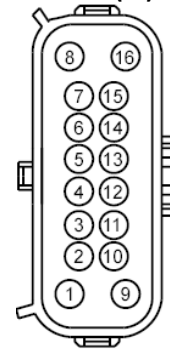

Female (F)

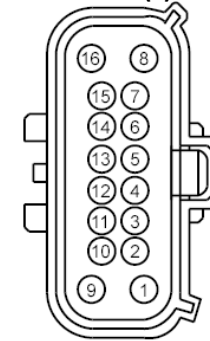

Rear Harness

Male (M)

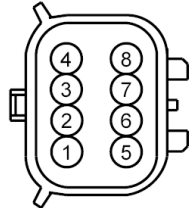

Female (F)

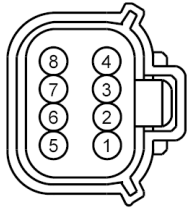

Switch/Gauge

Male (M)

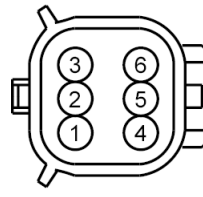

Female (F)

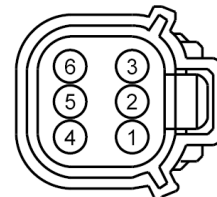

Pig Tail

Male (M)

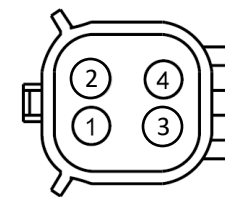

Female (F)

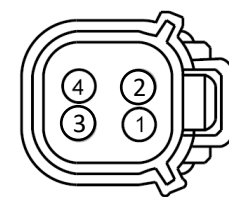

CNG Injector



Bosch LP Sensor

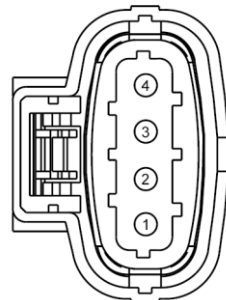

Bosch HP Sensor

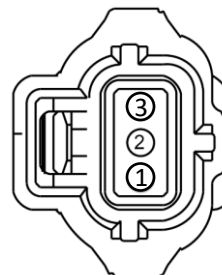

Solenoid

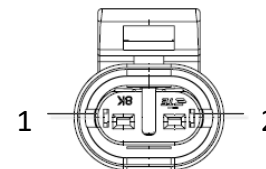

Female Disconnect #1 Ring Terminal

